



POLAR™

5th Gen



Beyond LED Technology's POLAR 5th Gen Flood light is the most economical and newest 2023 model. Our POLAR 5th Gen Flood light offers high lumens per watt for maximum power savings and rebates from power companies. This flood light is ideal to replace Halogen lamps and comes with a Yoke mount. Our POLAR 5th Gen Flood light is an extremely cost effective solution, great for illuminating yards, driveways, signage and security applications.

Product Features

- Up to 140 Lumens per watt
- Wattage Adjustable 200W/240W/300W
- Optional Screw-in Photocell
- Ultra thin sleek design
- Standard Yoke Mount bracket included
- Heat resistant polycarbonate optical lens
- Input Voltage 120-277Vac
- Die Cast Aluminum housing
- Bronze Housing
- UL & DLC Listed
- 5 Year warranty

POLAR™ 5th Gen



SKU #	Model #	Wattage Adj.	Lumens	CCT	Housing	Photocell	Input Voltage	Certifications
156596	BLT-SB19-300WBT3A1-BR10SPYMW50	200W/240W/300W	42000Lm	5000K	Bronze	Optional Screw-in Photocell	120-277V	UL & DLC

SKU #. 156596 Specifications

Parameter	Description	Value
General Performance	Model #	BLT-SB19-300WBT3A1-BR10SPYMW50
	Wattage Adjustable	200W/240W/300W
	Lumen	42000LM
	Lumen Efficacy	Up to 140LM/W
	Color Temperature	5000K
	CRI (Ra)	>80
	Beam Angle	153° x 111° (Type III)
Electrical	Input Voltage	120-277Vac
	Frequency	50/60Hz
	Dimming	0-10V Dimmable
	Power Factor	≥0.9
	Driver Surge Protection	L/N-PE: 6kV, L-N: 6kV
	Flicker Percent	<30%
	Driver Brand	Beyond LED Technology
Physical	Operating Temperature	Without Motion Sensor: -35°C TO 50°C; With Motion Sensor: -30°C TO 50°C
	Operating Humidity	5% -95% RH
	Storage Temperature	-25°C To 85°C
	Storage Humidity	5% - 95% RH
	LED Brand	Lumileds
	LED Type	SMD2835
	LED QTY	212*2 PC
	Housing	Die-cast aluminum
Housing Color	Bronze	
Qualification	IP Rating	IP65
	Warranty	5 Year



POLAR™

5th Gen

Correlated Color Temperature (CCT)

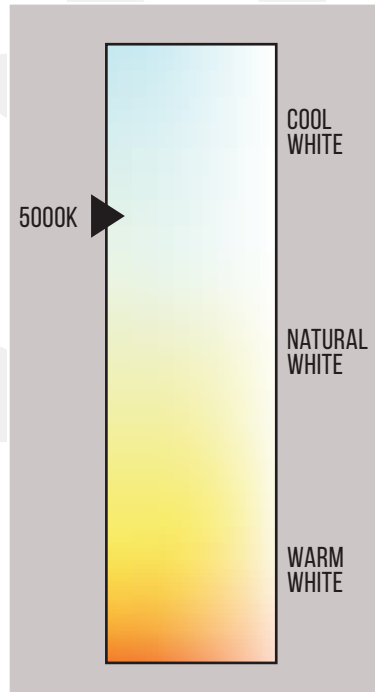

Dimensions

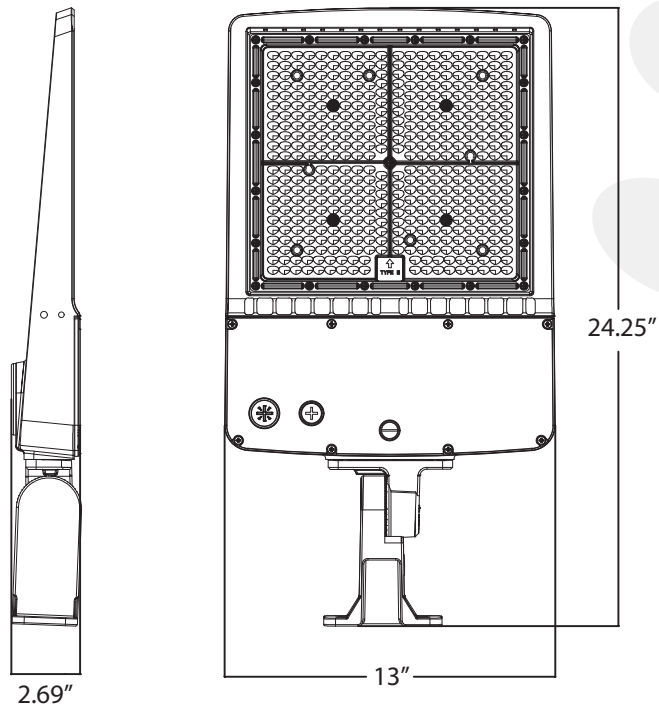

POLAR™ 5th Gen



Photometric Data

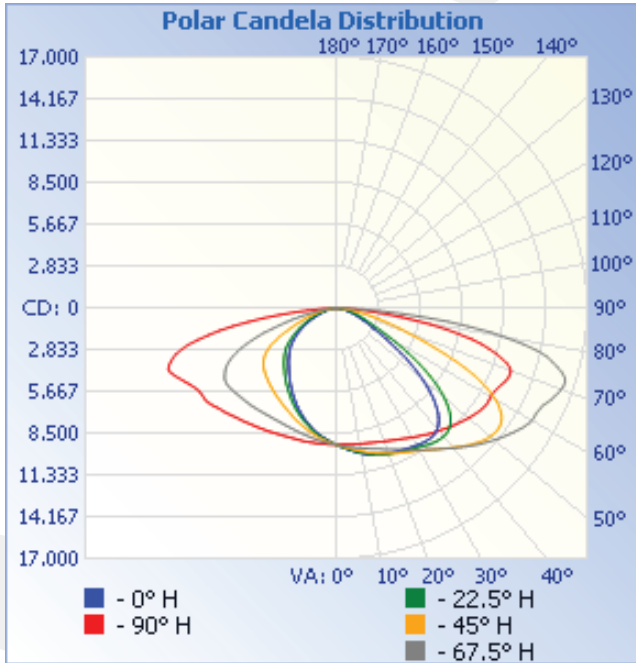

	Center Beam fc	Beam Width	
17.0ft	32.1 fc	49.6 ft	145.2 ft
34.0ft	8.0 fc	99.1 ft	290.4 ft
51.0ft	3.6 fc	148.7 ft	435.6 ft
68.0ft	2.0 fc	198.2 ft	580.8 ft
85.0ft	1.3 fc	247.8 ft	726.0 ft
102.0ft	0.9 fc	297.4 ft	871.2 ft

■ Vert. Spread: 111.1°
■ Horiz. Spread: 153.6°

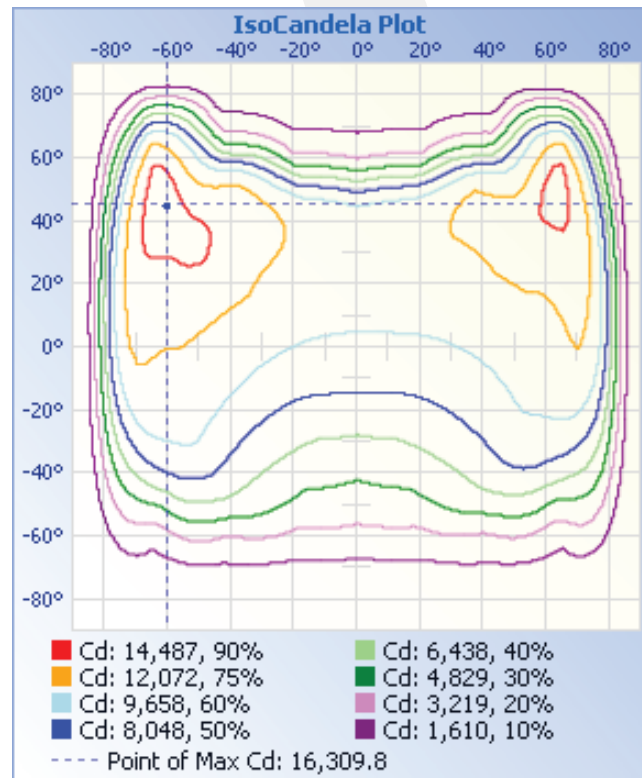
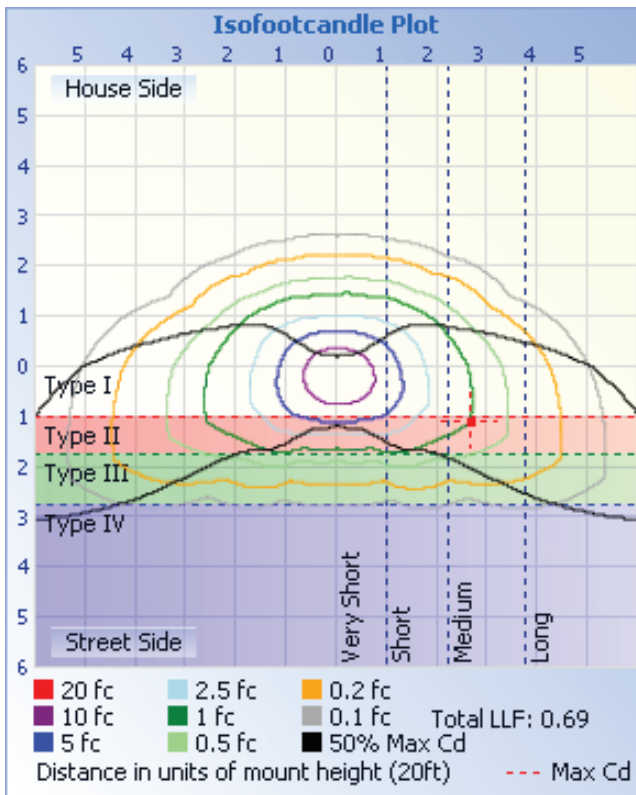

LED FLOOD LIGHT



POLAR™

5th Gen

Installation

Cautions:

1. Do not use any electric generator to test the LED light .
2. Please abide by related country, regional and local law and regulations when installing this fixture.
3. To avoid electrical shock and damage, please do not install the lights in raining days.

Notices:

1. To prevent from electric shock or fire risk, the installation must be conducted by operator who have professional electrical knowledge.
2. Please wear gloves to avoid injury before installing lamps.
3. During or after installation, if there are situations such as smoke, fire in the wires or lamps, please turn off the power immediately and notify relevant personnel of an overhaul.
4. This light can be used for outdoor installation.

Instructions:

1. This product has dimming and non-dimming function, which differs in installation ways.
2. 3 Dimming functions are available in this shoebox light:
 - (1). Constant current can be achieved by -10VDC dimming.
 - (2). PWM single dimming.
 - (3). Variation of resistance unit dimming (Please choose the appropriate dimming way according to your needs. You can also choose not to use this function).
3. Choose the wire connection ways, dimming ways and installation ways according to your needs and the LED fixture purchased.

Wiring Diagram:

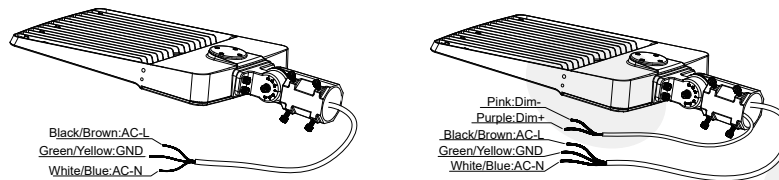

Optional Brackets and Installation Instructions:

There are 5 optional brackets for this fixture. The following are LED shoebox fixtures with different brackets

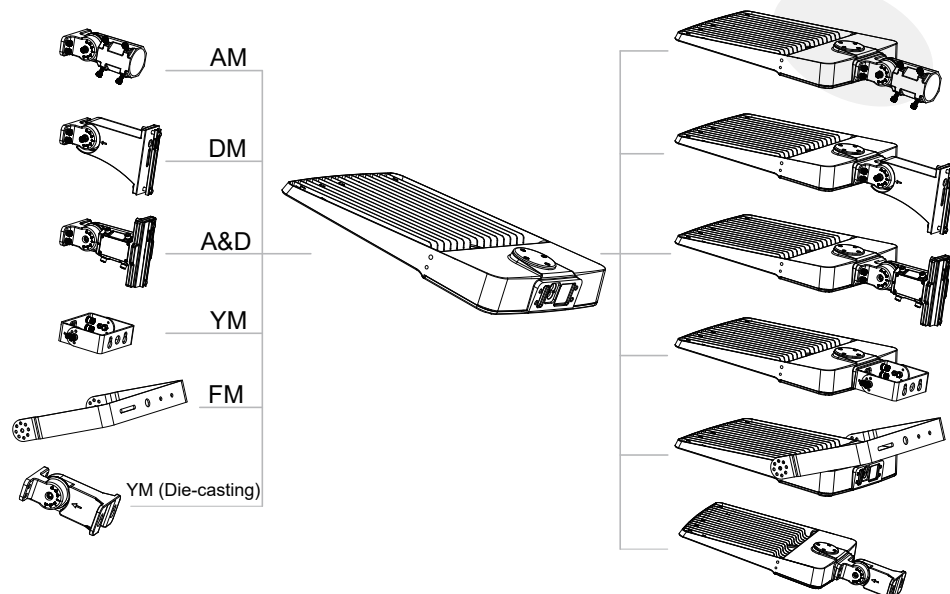

POLAR™

5th Gen



Installation

Note: Please turn off the power before installation to avoid accident.

Installation Instructions with different brackets:

1. ADJUSTABLE FITTER MOUNTING (AM)

- Step 1: Loosen the 4 screws on the bracket with a screwdriver and make sure that the bracket can fit into the light pole, Figure 1-1;
- Step2: Connect the input wires of the fixture to the mains correctly, Figure 1-2;
- Step3: Mount the fixture on the light pole and fix it with screws firmly to ensure that the fixture cannot be rotated or shaken, Figure 1-3;
- Step4: If the installation angle of the fixture needs to be adjusted, loosen the screws of the bracket and fix them again after finished adjustment, Figure 1-4;

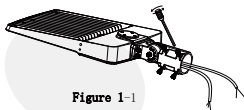

Figure 1-1

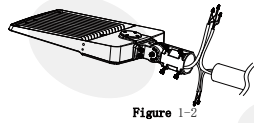

Figure 1-2

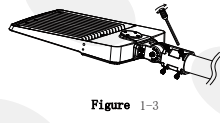

Figure 1-3

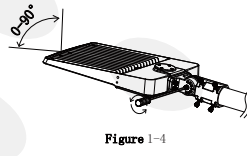

Figure 1-4

2. DIRECT MOUNTING (DM)

- Step1: Loosen the screws on the bracket with a screwdriver and take off the bracket, Figure 2-1;
- Step2: Fix the fixture on the pole after passing the input wire of the fixture through the pole and then connect the input wires to the mains properly, Figure 2-2;
- Step3: Fasten the pole cover to the pole after making sure the wires are connected correctly, Figure 2-3;
- Step4: If the installation angle of the fixture needs to be adjusted, loosen the screws of the bracket and fix them again after finished adjustment, Figure 2-4;

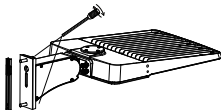

Figure 2-1

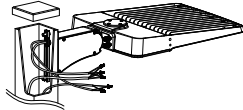

Figure 2-2

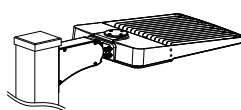

Figure 2-3

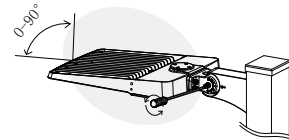

Figure 2-4

3. ADJUSTABLE FITTER MOUNTING & DIRECT MOUNTING (A&D)

Installation-1

- Step1: Loosen the screws on the bracket with a screwdriver and take off the bracket, Figure
- Step2: Fix the fixture on the pole after passing the input wire of the fixture through the pole and then connect the input wires to the mains properly, Figure 3-1-2;
- Step3: Fasten the pole cover to the pole after making sure the wires are connected correctly, Figure 3-1-3;
- Step4: If the installation angle of the fixture needs to be adjusted, loosen the screws of the bracket and fix them again after finished adjustment, Figure 3-1-4;

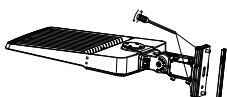

Figure 3-1-1

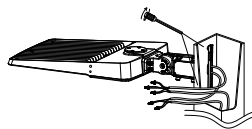

Figure 3-1-2

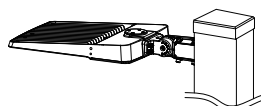

Figure 3-1-3

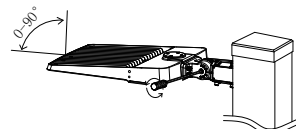

Figure 3-1-4



POLAR™

5th Gen

Installation

Installation-2

Step 1: Loosen the 4 screws on the bracket with a screwdriver and make sure that the bracket can fit into the light pole, Figure 3-2-1;

Step2: Connect the input wires of the fixture to the mains correctly, Figure 3-2-2;

Step3: Mount the fixture on the light pole and fix it with screws firmly to ensure that the fixture cannot be rotated or shaken, Figure 3-2-3;

Step4: If the installation angle of the fixture needs to be adjusted, loosen the screws of the bracket and fix them again after finished adjustment, Figure 3-2-4;

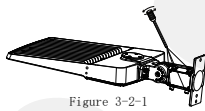

Figure 3-2-1

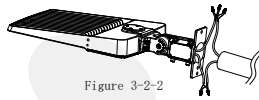

Figure 3-2-2

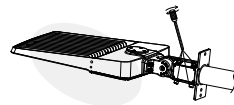

Figure 3-2-3

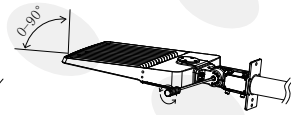

Figure 3-2-4

4.YOKE MOUNTING (YM)

Step1: Use a tool to punch two 67MM holes on the wall and then insert 2 expansion screws into the holes, Figure 4-1;

Step2: Fix the fixture on the expansion screws, Figure 4-2;

Step3: Connect the input wires of the fixture to the mains properly, Figure 4-3;

Step4: If the installation angle of the fixture needs to be adjusted, loosen the screws of the bracket and fix them again after finished adjustment, Figure 4-4;

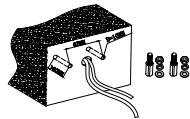

Figure 4-1

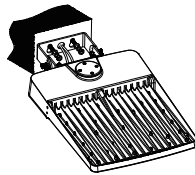

Figure 4-2

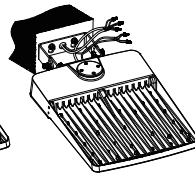

Figure 4-3

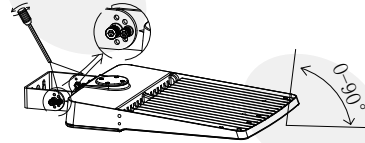

Figure 4-4

5.FLOOD MOUNTING (FM)

Step1: Pass the connecting wires of the fixture through the hole on the FM bracket, Figure 5-1;

Step2: Connect the input wires of the fixture to the mains properly, Figure 5-2;

Step3: Fix the fixture to the FM bracket with screws, Figure 5-3;

Step4: If the installation angle of the fixture needs to be adjusted, loosen the screws of the bracket and fix them again after finished adjustment, Figure 5-4;

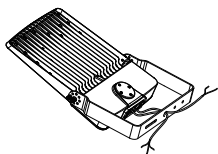

Figure 5-1

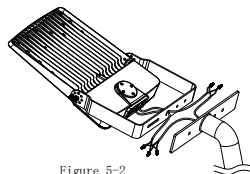

Figure 5-2

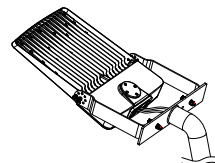

Figure 5-3

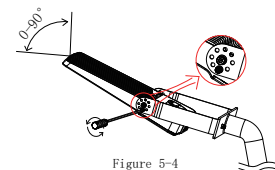

Figure 5-4

POLAR™

5th Gen



Installation

6. YOKE MOUNTING [YM (Die-casting)]

Step 1: Drill holes on the wall as shown.(Figure 6-1)

Step 2: Knock the expansion bolts into the wall.(Figure 6-2)

Step 3: Connect the fixture to the bracket and tighten the screws; connect the wires properly and put them into junction box.(Figure 6-3)

Notice: Adjustable angle is 0-90°(Figure 6-3)

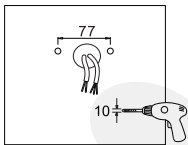

Figure 6-1

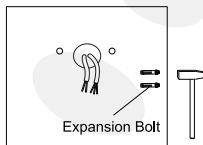

Figure 6-2

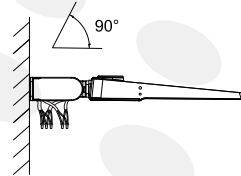

Figure 6-3

Operate as following instructions if the product is designed with below functions

Special functions instruction

Wattage adjustment Instruction

1. Remove the 3/4 plug with a screwdriver
2. Adjust the internal wattage switch to get the desired wattage
3. Tighten the 3/4 plug after adjusted to the desired wattage

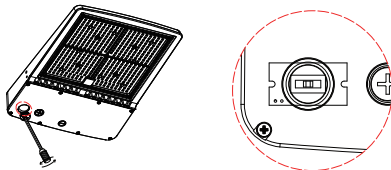

Instructions for Photocell

1. Take off the shorting cap from the fixture
2. Insert the AC photocell into the base and make sure the direction is correct
3. Screw in the photocell

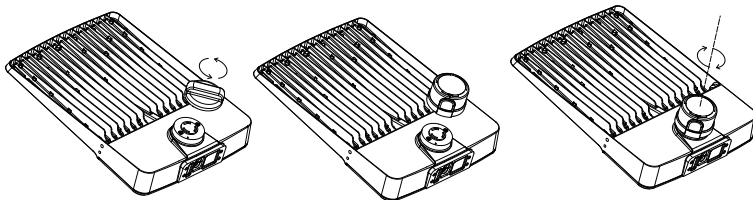

Instructions for sensor

1. Remove the 1/2 plug with a screwdriver
2. Screw in the sensor

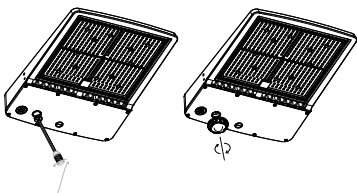



POLAR™

5th Gen

Packaging

SKU	Dimension (Inches)	Qty	Net Weight	Gross Weight
156596	27.56 x 14.76 x 5.63	1	10.6 LBS	13.9 LBS

Application Images



POLAR™

5th Gen



Application Images



LED FLOOD LIGHT

Warranty

5 Year Warranty